

PRODOTTI / RICAMBI
PRODUCTS / SPARE PARTS
PRODUITS / PIÈCES DÉTACHÉES
PRODUKTE / ERSATZTEILE
PRODUCTOS / REPUESTOS

PRONTOBAR

Esplosi

01-08-2011

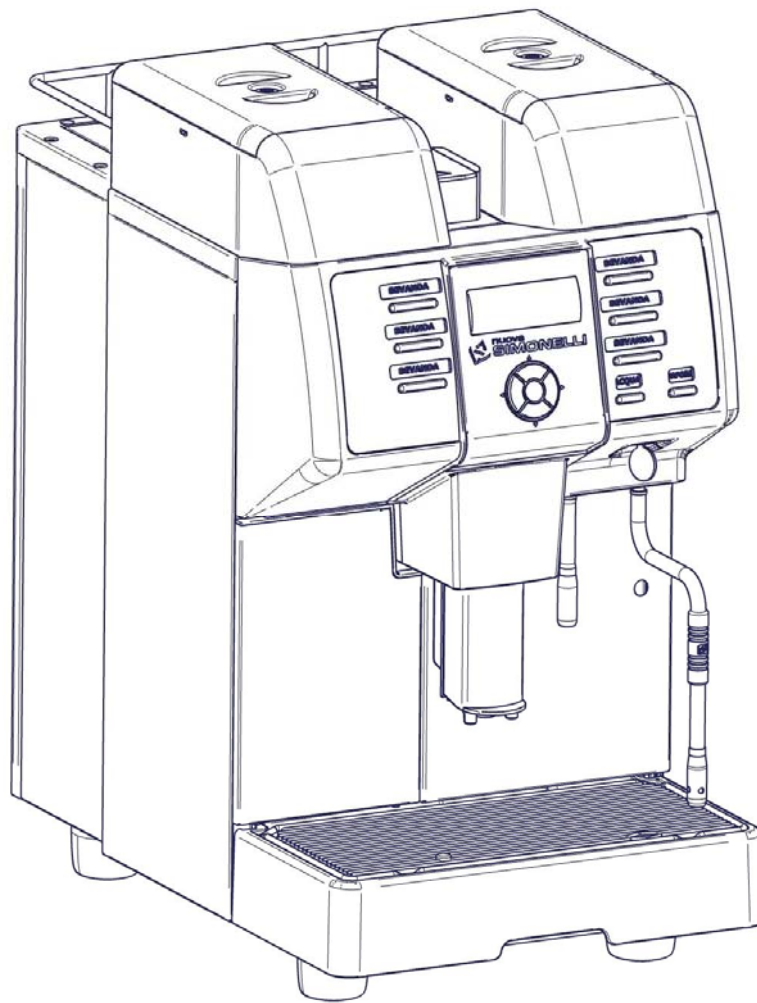

 nuova
SIMONELLI®

MODIFICARE COME TAVOLE

- » TAV □1 - **COMPONENTI GRUPPO CARENA**
CABINET PARTS
- » TAV □2 - **COMPONENTI TELAIO - TANICA**
TANK FRAME PARTS
- » TAV □3 - **COMPONENTI CALDAIA**
BOILER PARTS
- » TAV □4 - **COMPONENTI GRUPPO EROGAZIONE**
POURING UNIT GROUP PARTS
- » TAV □5 - **COMPONENTI MACININI**
GRINDERS PARTS
- » TAV □6 - **COMPONENTI ELETTRICI ED ELETTRONICI**
ELECTRONIC & ELECTRIC PARTS
- » TAV □7 - **COMPONENTI POMPA LANCIA VAPORE-ACQUA CALDA**
COMPONENT PUMP – STEAM – HOT WATER
- » TAV □8 - **COMPONENTI IDRAULICI**
HYDRAULIC COMPONENT

» LEGENDA :

I CODICI SCRITTI IN GRASSETTO SI RIFERISCONO AI COMPONENTI IMPIEGATI ATTUALMENTE.

I CODICI IMPIEGATI PRIMA SONO SCRITTI IN CORSIVO CON INDICATA A FIANCO LA DATA DI FINE VALIDITA'.

ESEMPIO:

07300127 (φ2.5) - 16/05/2007
07300226 (φ2)

COMPONENTI GRUPPO CARENA CABINET PARTS

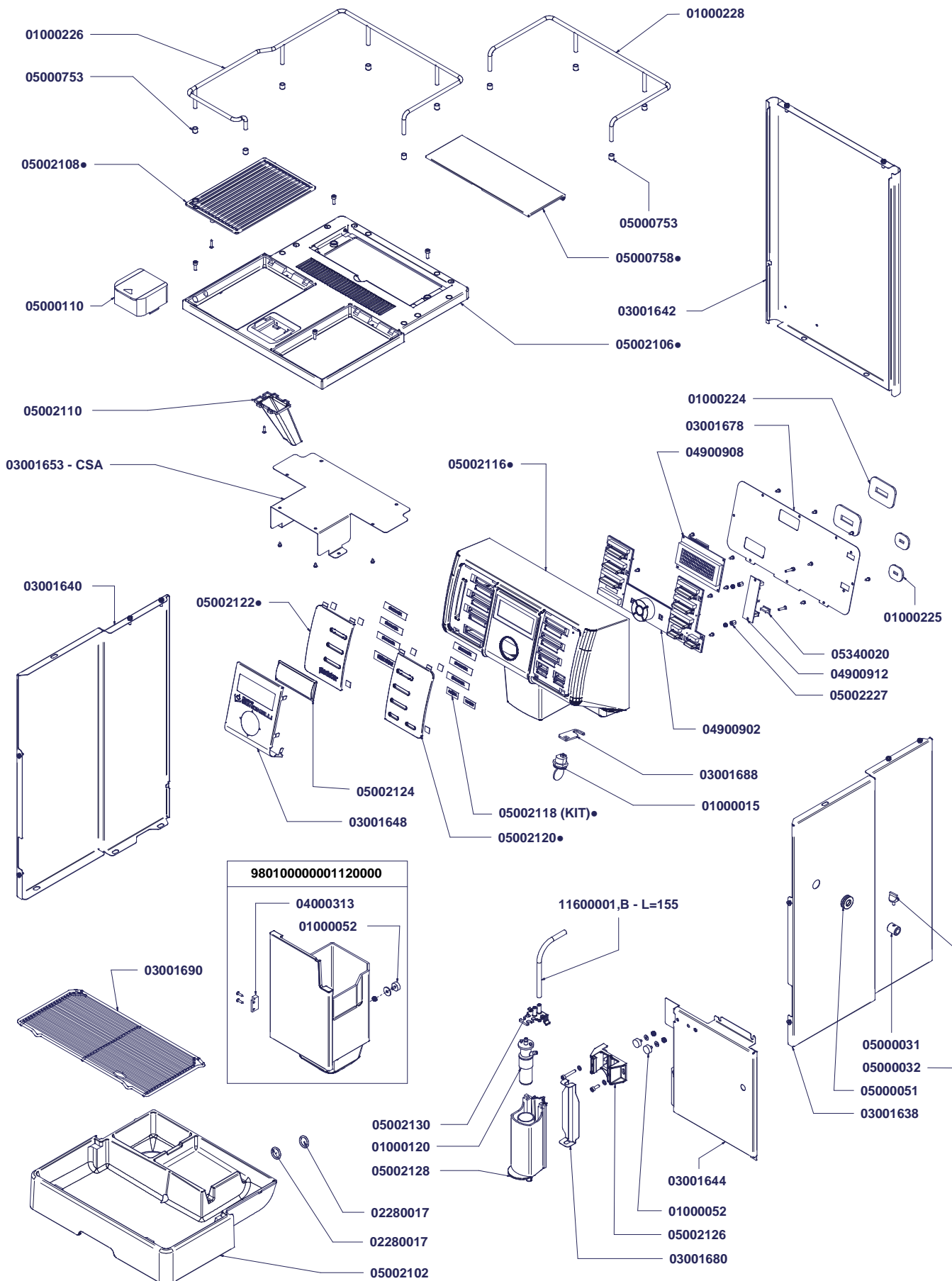

COMPONENTI TELAIO TANICA

TANK FRAME COMPONENTS

P
R
O
N
T
O
B
A
R

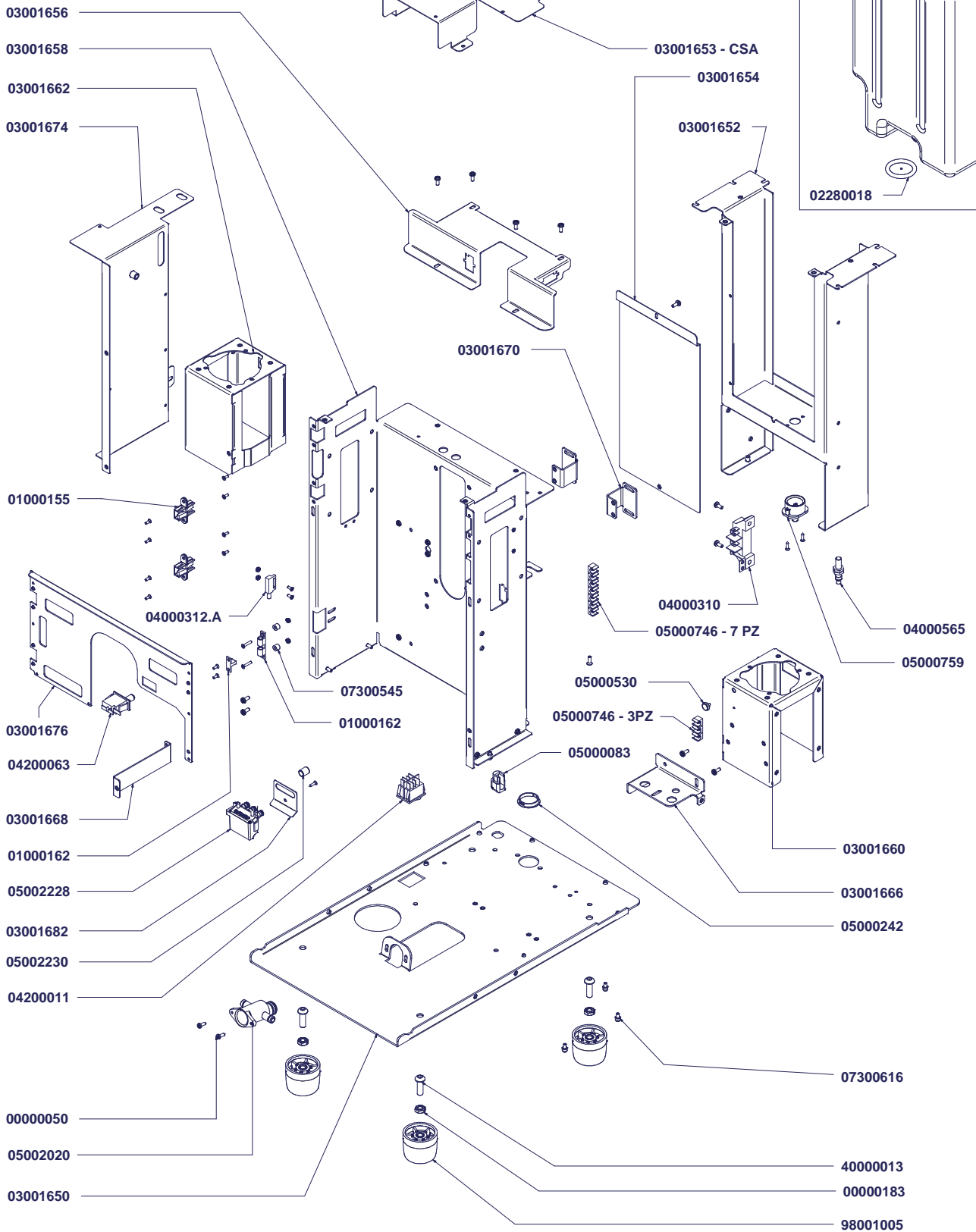

COMPONENTI CALDAIE BOILERS COMPONENTS

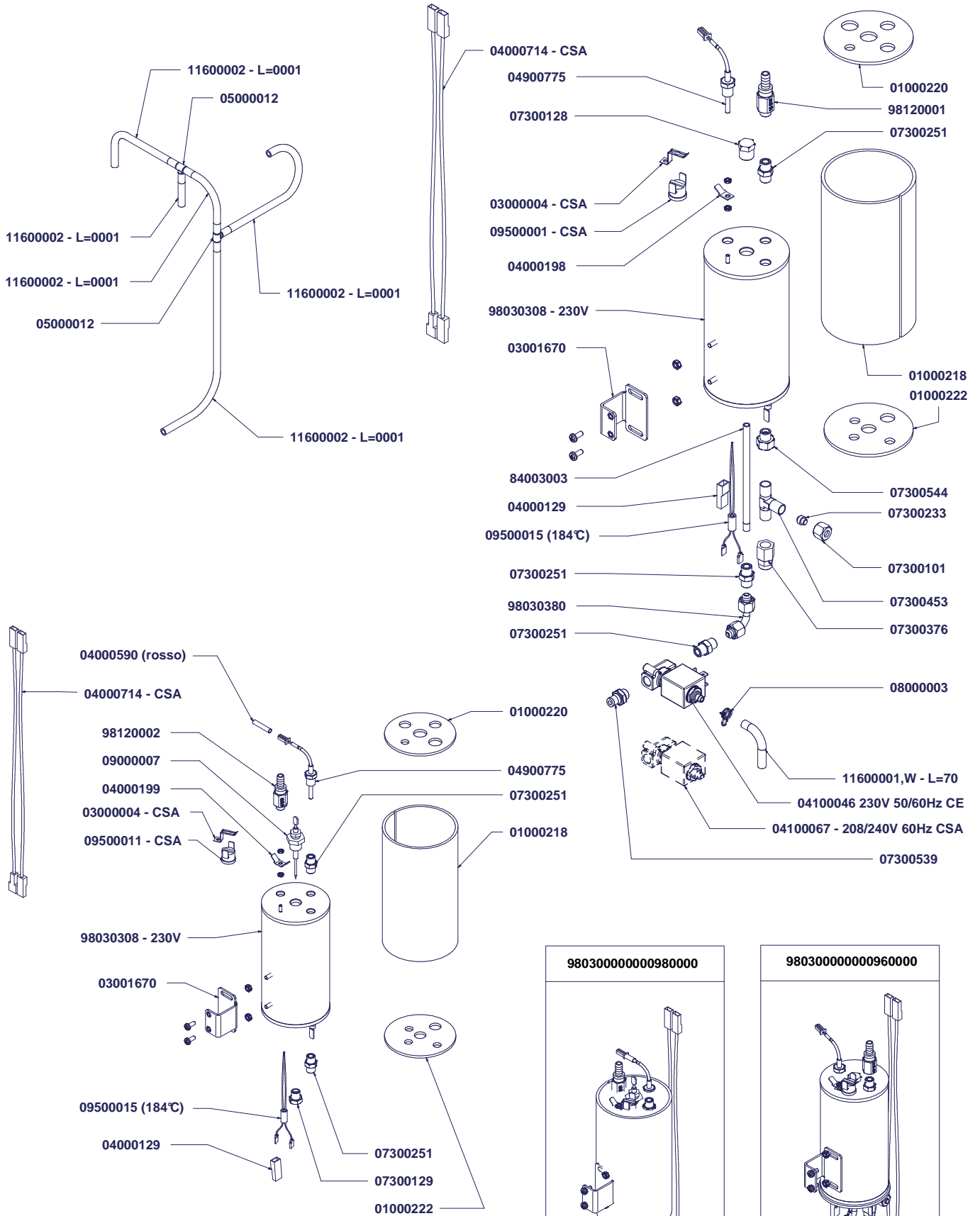

COMPONENTI GRUPPO EROGAZIONE GROUP UNIT COMPONENTS

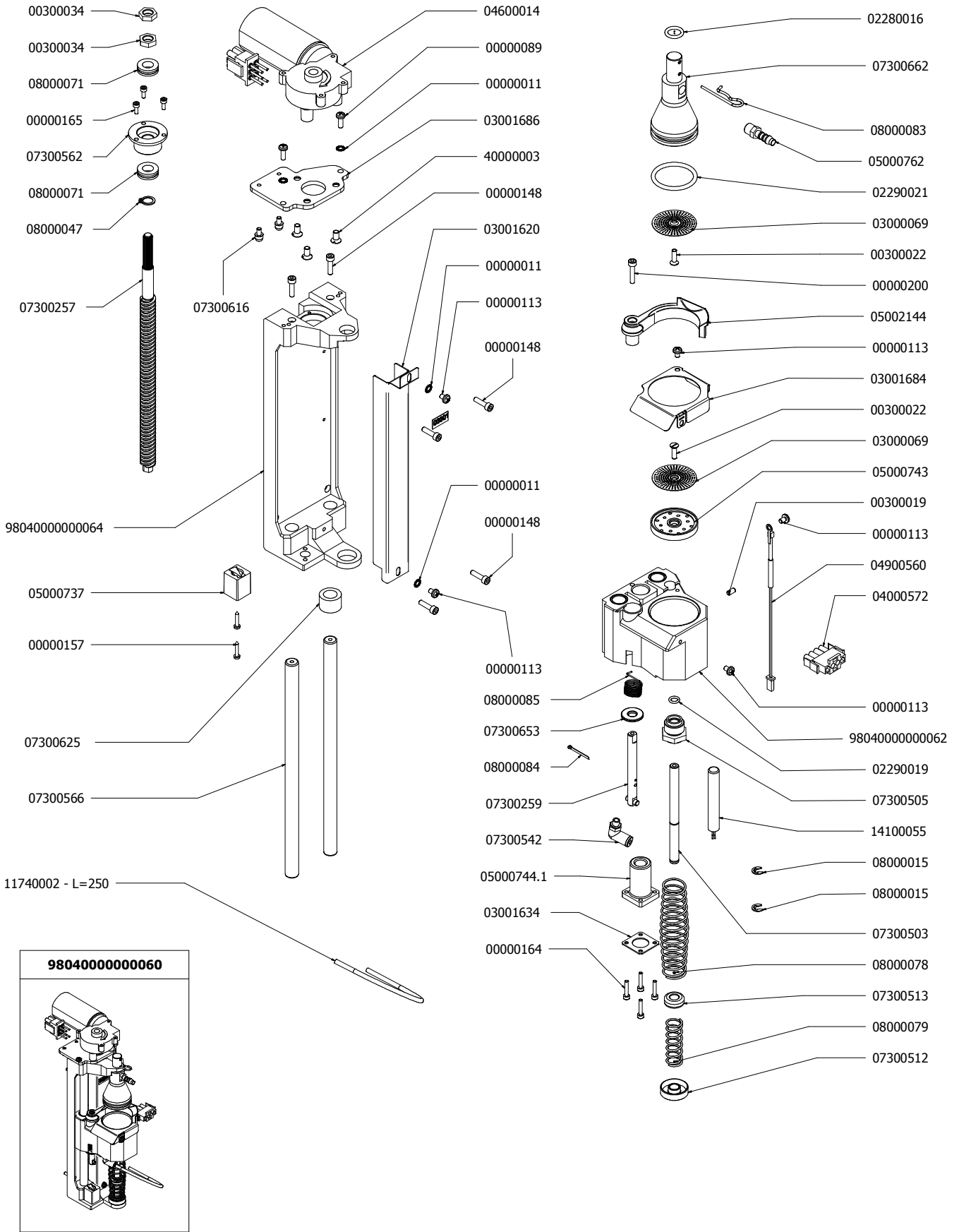

COMPONENTI MACININI GRINDERS COMPONENTS

9814000000032

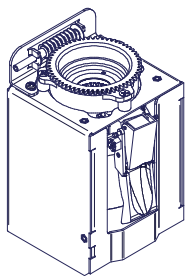

9814000000030

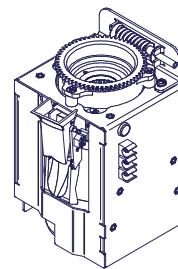

9801000000118

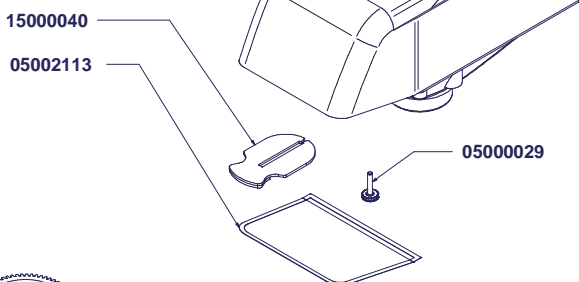
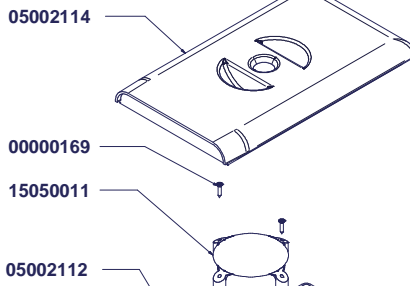
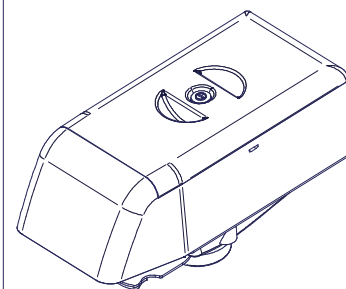

84005001

15800045

00000134

15800038

02290025

00000134

15800045

00000044

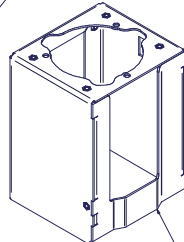
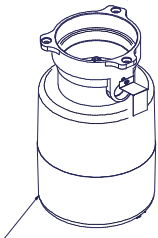
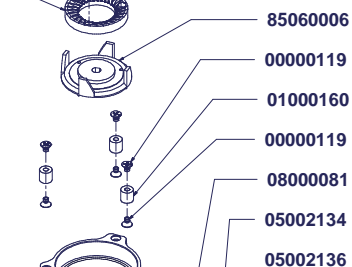
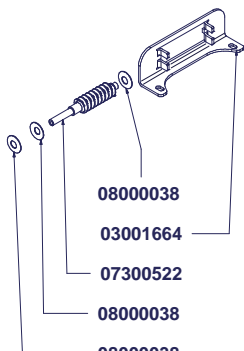

84005001

02290025

15800045

00000134

15800038

00000134

15800045

00000119

01000160

00000119

85060006

08000081

05002134

03001536

00000165

05002132

03001536

05002138

05002142

05000746 - 3PZ

05000530

00000165

03001660

08000038

08000038

07300522

08000038

03001664

00000044

84005003-4

COMPONENTI ELETTRICI ELECTRIC PARTS

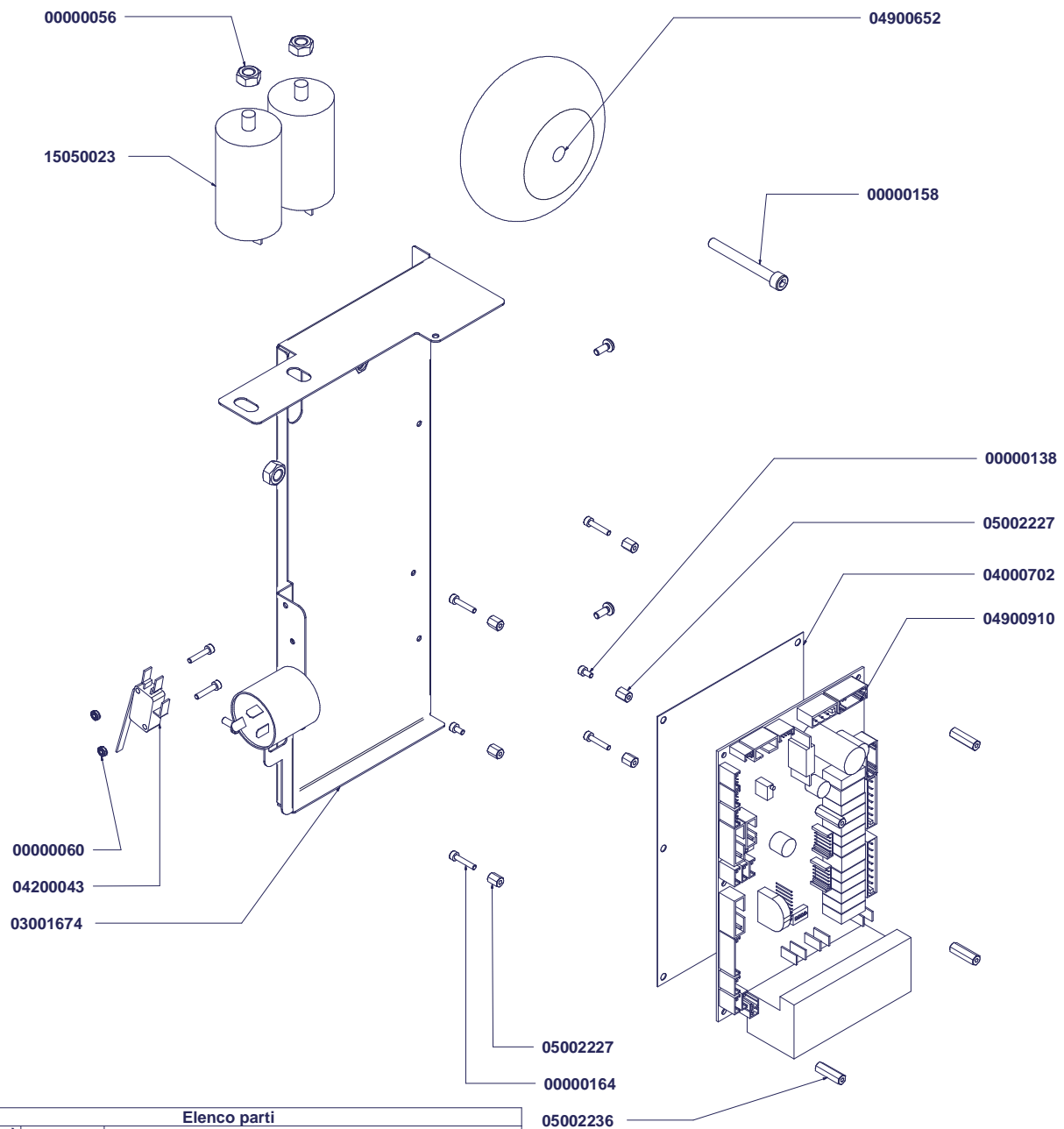

Elenco parti			
POS	QTÀ	CODICE	NOME FILE
1	1	04000562	04000562 Cavo H05VV-F 3x1,5 2mt Europa spina Shuko 90°.ipt
2	1	04000704	04000704 CAVO INTERRUTTORE - MORSETTO PRONTOBAR 2009.ipt
3	1	04000604	04000604 SUPPLEMENTO EV ENTRATA MICROBAR 2004 ACQUASTOP.ipt
4	1	04000700	04000700 IMPIANTO ELETTRICO PRONTOBAR 2009.ipt

Elenco parti			
POS	QTÀ	CODICE	NOME FILE
1	1	04000670	04000670 CAVO VENTOLINO TANICA L=450.ipt
2	1	04000672	04000672 CAVO VENTOLINO AD L=450.ipt
3	1	04000706	04000706 CAVI BASSA TENSIONE (MOTORE - LIVELLO CALDAIE + SERBATOIO).ipt
4	1	04000708	04000708 CAVI SICUREZZA (PROTEZIONE PORTA + CASSETTO FONDI).ipt
5	1	04000710	04000710 CAVO DISPLAY PRONTOBAR 2009.ipt
6	1	04000712	04000712 CAVO TASTIERA PRONTOBAR 2009.ipt
7	1	04000716	04000716 CAVO CENTRALINA USB PRONTOBAR.ipt

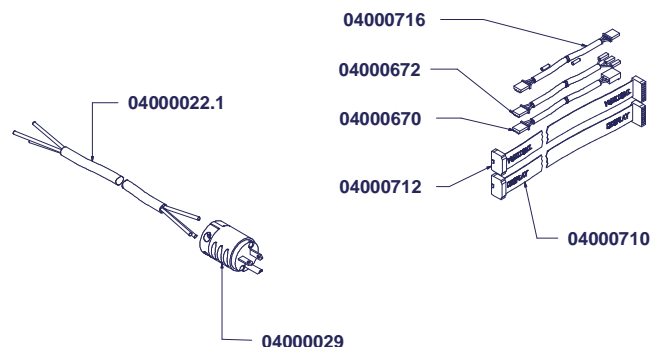

COMPONENTI POMPA E LANCE VAPORE ACQUA

COMPONENT PUMP - STEAM - HOT WATER

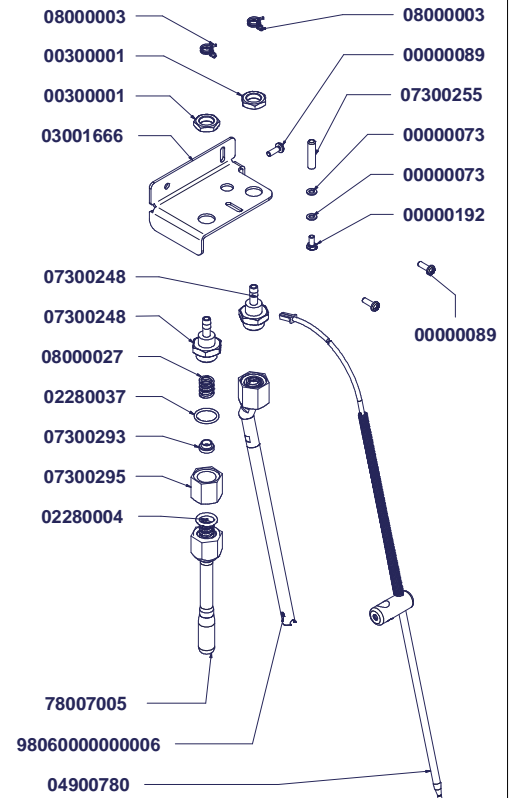
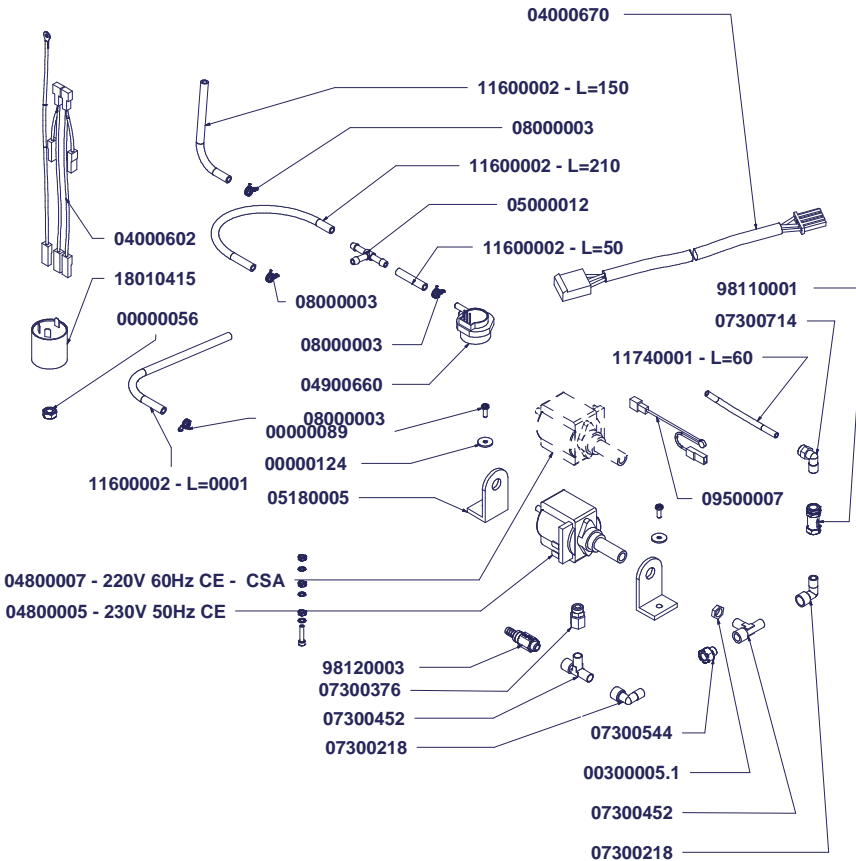
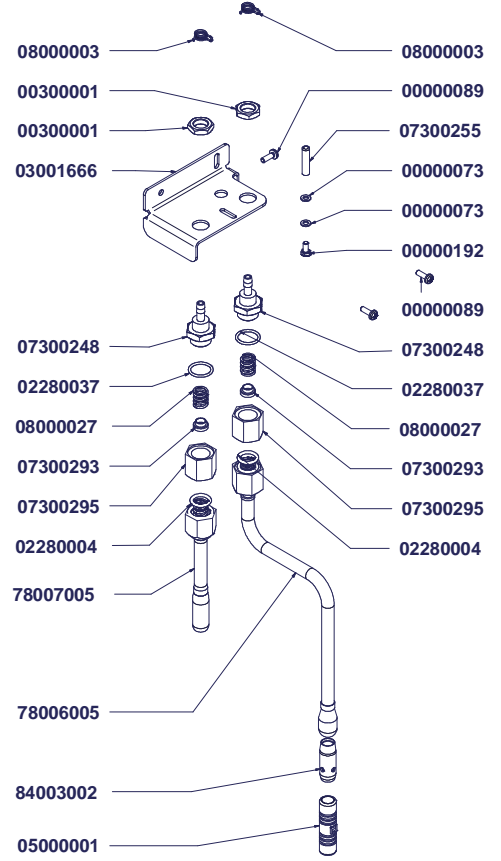
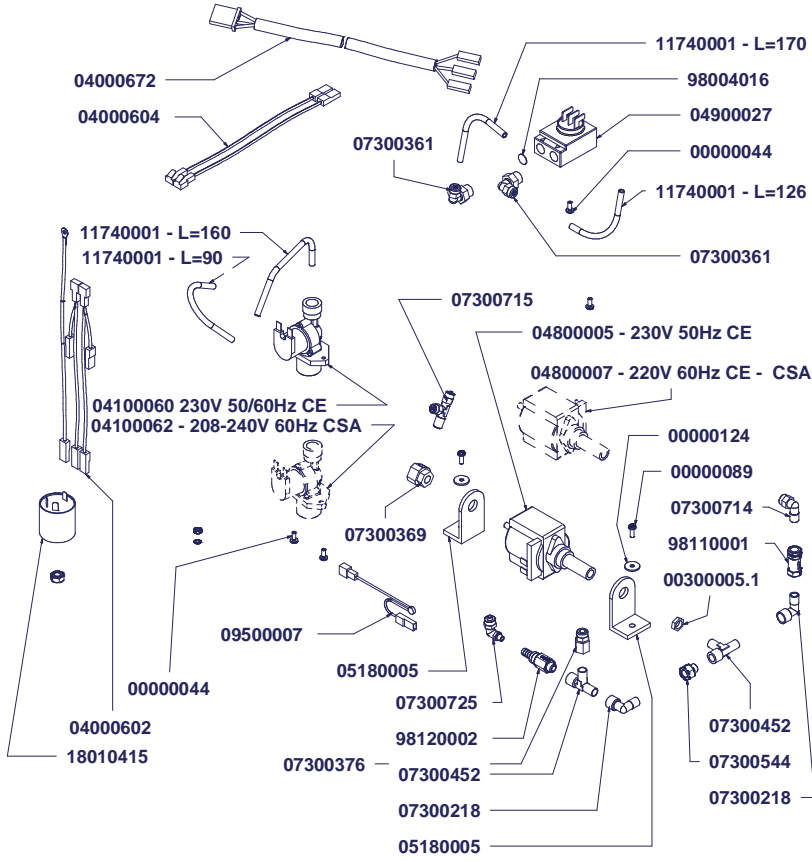

COMPONENTI IDRAULICI HYDRAULIC COMPONENT

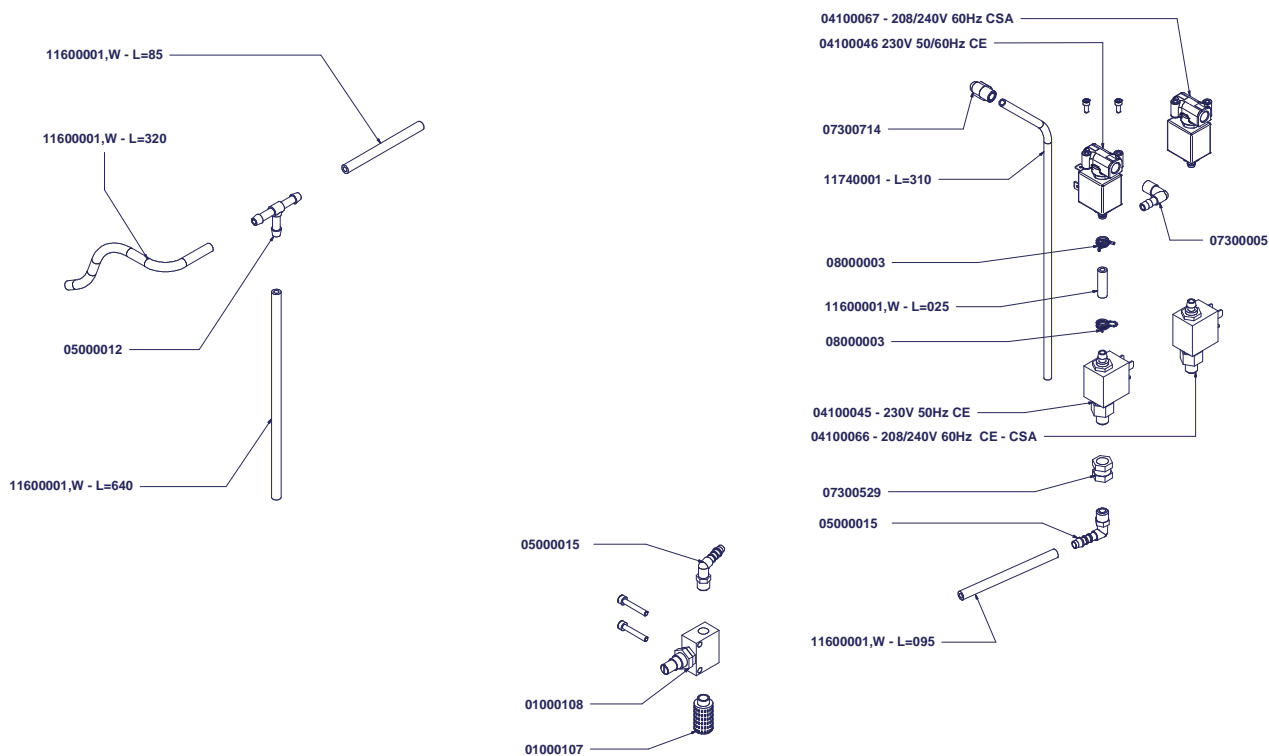
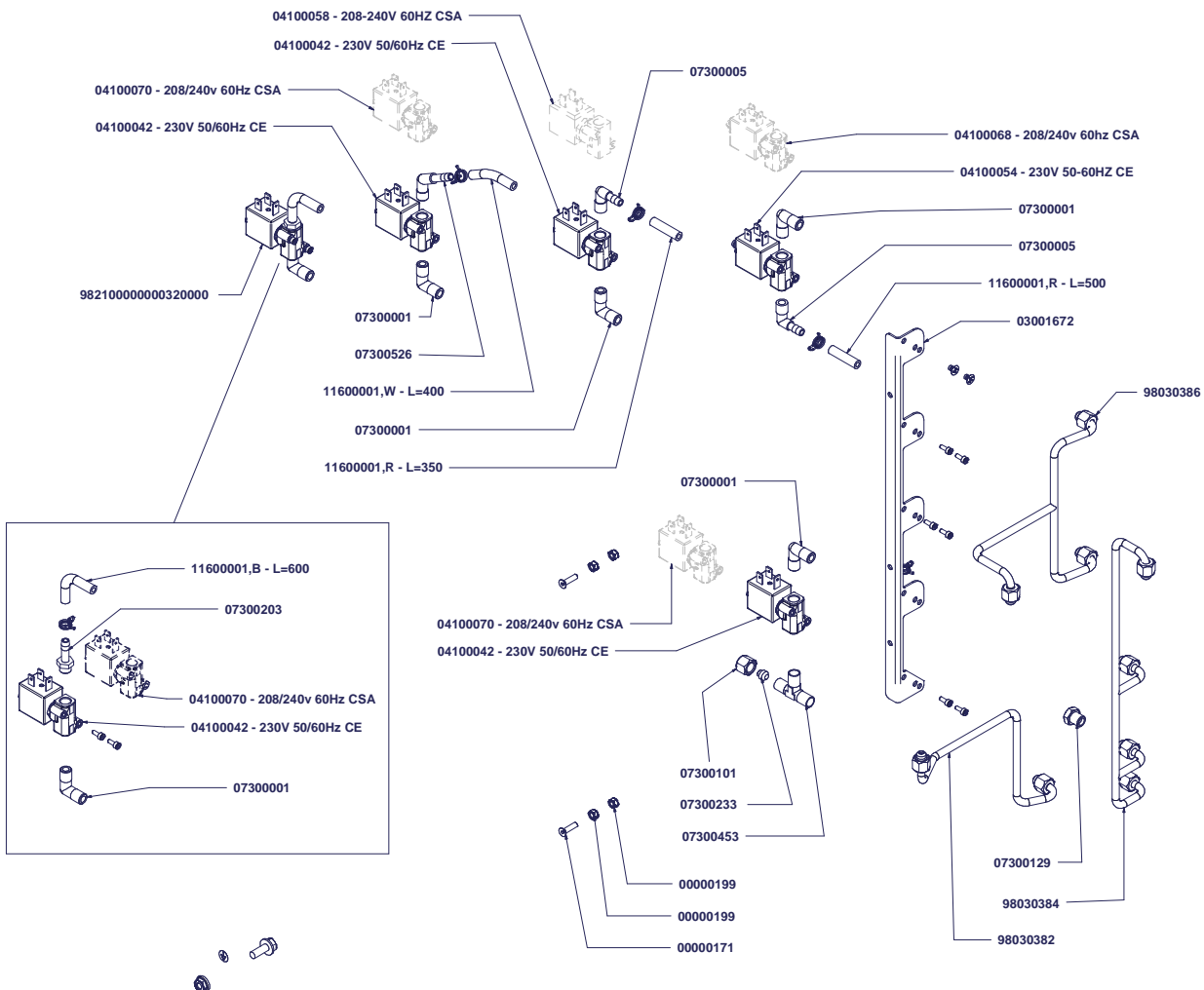

CODICE	DESCRIZIONE	DESCRIPTION	DATA FINE VALIDITA'
00000011	RONDELLA INOX M4 ZIGRINATA UNI8842/A	STAINLESS STEEL KNURLED WASHER D4	
00000044	VITE AQ M4x10 TC T.CR. ZINC	GALVANISED CROSS HEAD CAP SCREW M4x10	
00000050	VITE AUTOF 3,5x12 TC/T.CR. TRUCIOLARE	CROSSHEAD CAP SELF-TAPPING SCREW 3,5x12	
00000054	DADO AQ M4 ALTO ZINCATO	NUT M4 HIGH GALVANISED NUT	
00000056	DADO AQ M8 ALTO ZINCATO	ZINC COATED NUT AQ M8 HIGH	
00000073	RONDELLA INOX 8x4x1 UNI6592	STAINLESS STEEL WASHER D.8x4x1	
00000113	VITE INOX M4x6 TC T.CR. 7985	SS CROSSHEAD CAP SCREW M4x6	
00000119	VITE INOX M4x6 TSPTCR ISO 7046	SS CROSS HEAD COUNTERSUNK SCREW M4x6	
00000130	VITE INOX M4x25 TCEI UNI 5931	SS HEX SOCKET CAP SCREW M4x25	
00000133	FASCETTA INOX WD12 16-25 C7 W2	STAINLESS STEEL GIRDLE WD12 16-25 C7 W2	
00000134	VITE AQ M3x6 TC TC ZINC. UNI6107	GALVANISED SCREW M3x6 TCTC UNI6107	
00000138	VITE AQ M3x6 TCEI ZINC.	GALVANISED SCREW M3x6 TCEI	
00000148	VITE INOX M4x16 TCEI UNI 5931	STAINLESS STEEL SCREW M4x16 TCEI UNI 5931	
00000150	VITE INOX M4x6 TBEI ISO 7380	STAINLESS STEEL M4x6 TBEI ISO 7380	
00000157	VITE AUTOF INOX 2,9x16 TC T.CR DIN 7981	SELF-THREADING STAINLESS STEEL SCREW 2.9x16 TCTCR	
00000158	VITE INOX M6x55 TCEI UNI 5931	SS SCREW M6x55 TCEI UNI 5931	
00000161	VITE INOX M3x16 TSPEI UNI 5933	STAINLESS STEEL SCREW M3x16 TSPEI 5933	
00000164	VITE INOX M3x16 TCEI ISO 4762	STAINLESS STEEL SCREW M3x16 TCEI ISO 4762	
00000165	VITE INOX M3x8 TCEI ISO 4762	STAINLESS STEEL SCREW M3x8 TCEI ISO 4762	
00000169	VITE AUTOF INOX 2,9x13 TSP/TCR	SS SELF-THREADING SCREW 2.9x13 TSP/TCR	
00000171	VITE INOX M4x16 TSPEI UNI 5933	STAINLESS STEEL SCREW M4x16 TSPEI UNI 5933	
00000175	VITE INOX M4x10 TC TCR	SS CROSS HEAD CAP SCREW M4X10	
00000183	DADO INOX M8 BASSO 5589 h5	STAINLESS STEEL NUT M8 LOW 5589 h5	
00000192	VITE INOX M4x8 TE UNI 5739	STAINLESS STEEL SCREW M4x8 TE UNI 5739	
00000199	DADO INOX M4 MEDIO UNI 5588	NUT M4 MEDIUM STAINLESS UNI 5588	
00300001	DADO OT 1/4 GAS SPESS.5 CH18 *AGG. 22.07.96	BRASS NUT 1/4 GAS SPESSOR 5	
00300005.1	DADO OT 1/8 GAS MAGGIORATO 0.15mm SPESS.4 CH13	BRASS NUT 1/8 GAS	
00300017	DADO AUTOBLOC INOX M4 ALTO DIN982	SELF-LOCKING STAINLESS STEEL NUT M4 HIGH DIN 982	
00300019	GRANO INOX M4X6 UNI 5923 PP	STAINLESS STEEL DOWEL M4X8 5923	
00300022	VITE INOX M4x14 TSP TC DIN963	INOX SCREW M4X14 TSP TC DIN963	
00300034	DADO OT M10X1.25 SPESS.4.5 CH14	BRASS NUT M10 THICK 4.5 HEXAGON 14mm DIN 982	
01000015	SERRATURA INVOLUCRO COMANDI	CONTROL BOARD DOOR LOCK	
01000052	CALAMITA RPV 14	MAGNET RPV 14	
01000087	TUBO SCARICO 18x24,4	DRAINING TUBE 18x24,4	
01000092	TUBO CARICO ACQUA 1,5mt EPDM 3/8F OTT. - 3/4F90°	3/8F-3/4F90° WATER CHARGE PIPE 1,5mt	
01000107	SILENZIATORE 1/8 491	SILENCER 1/8 491	
01000108	RUBINETTO MRF 1/8 F-F 604	TAP 1/8 F-F	
01000120	CAPPUCCINATORE NSF "MICROBAR"	NSF MILK FOAMER FOR MICROBAR	
01000155	CERNIERA SPORTELLO MICROBAR CEAM 503 43x10	MICROBAR DOOR HINGE CEAM 503 43x10 NICKEL-PLATED	
01000160	ANTIVIBRANTE CD10x10 M4 FF	VIBRATION-DAMPING DEVICE D10x10 M4 FF	
01000162	SCROCCHETTO COMPL. MICROBAR	MICROBAR LOCK COMPLETE BCT-40	
01000218	ISOLANTE CALDAIA D80 115X252,7	BOILER INSULATION D.80 115 x 253	
01000220	ISOLANTE SUPER. D.80 CALDAIA	BOILER UPPER INSULATION D.80	
01000222	ISOLANTE INFER. D.80 CALDAIA	BOILER LOWER INSULATION D.80	
01000224	PROTEZ. PASSAGGIO CAVI MOUSSE ADESIVA SP.3	ADHESIVE INSULATING MOUSSE FOR CABLE GLAND SP.3 - PRONTOBAR	
01000225	PROTEZ. PASSAGGIO CAVI USB MOUSSE ADES. SP.3 PRONTOBAR	ADHESIVE INSULATING MOUSSE FOR CABLE USB	
01000226	CORNICE INOX COPERCHIO CARENA PRONTOBAR 1 CAMPANA	STAINLESS STEEL FRAME CASE COVER - PRONTOBAR 1 FUNNEL	
01000228	CORNICE INOX COPERCHIO CARENA PRONTOBAR 2 CAMPANE	STAINLESS STEEL FRAME CASE COVER - PRONTOBAR 2 FUNNELS	
02000005	OR SUP. CAPPUC. MICROBAR SILICONE ROSSO	UPPER GASKET FOR MICROBAR CAPPUCCINO MAKER	
02000006	OR INF. CAPPUC. MICROBAR	LOWER GASKET FOR MICROBAR CAPPUCCINO MAKER	
02280004	GUARN. OR 115 D.17 EP856 SNODO LANCIA	GASKET OR 115 D17 EP856 x SWIVEL STEAM PIPE	
02280007.V	GUARN. OR R5A D.10 DF801 VITON	ORING GASKET R5A D.10 DF801 VITON	
02280011	GUARN. OR R11 D19 EP 851	GASKET O RING R11 D19 EP 851	
02280016	GUARN. OR 115 D.17 VITON DF801	O RING 115 D.17 VITON DF801	
02280017	GUARN. OR R3062/AN12 D21 EP851	ORING GASKET R3062/AN12 D21 EP851	
02280018	GUARN. OR R11 D19 SILICONE ROSSO Sh70	RED SILICON GASKET O RING Sh70	
02280037	GUARN. OR CHIUSURA SNODO 16x2 NBR70	GASKET OR JOINT LOCK 16x2	
02290019	GUARNIZIONE OR R6 DF801 VITON	GASKET O-RING LOWER PISTON OR R6 DF801	
02290021	GUARN. OR 140/4137 D.41.5 SILICONE ROSSO Sh70	GASKET O-RING 140/4137 D.41.5 SILICON RED Sh70	
02290025	GUARN. OR3193 VITON x MACININO	VITON GRINDER GASKET O-RING 3193	
03000004	STAFFA SINGOLA x TERMOSTATO	STEEL HOLDER FASTOM FOR TERMOSTAT	
03000069	DOCCIA INOX D.40 x M4 T.SVP AGG.08.01.99	STAINLESS SPOUT D.40	
03001536	LINGUETTA SCIVOLO CAFFE' MICROBAR	MICROBAR COFFEE CHUTE TAB	
03001620	LAMIERINO PROTEZ. VITE ELIC. MICROBAR 08	GROUP PROTECTION PLATE	
03001634	PIASTRINA FISSAGGIO CHIOCCIOLA VITE GRUPPO	FASTENING PLATE FOR MICROBAR 08 GROUP SCREW VOLUTE	
03001638	CARENA DX INOX PRONTOBAR	RIGHT SIDE STAINLESS STEEL CASE - PRONTOBAR	
03001640	CARENA SX INOX PRONTOBAR	LEFT SIDE STAINLESS STEEL CASE - PRONTOBAR	
03001642	CARENA RETRO INOX PRONTOBAR	REAR STAINLESS STEEL CASE - PRONTOBAR	
03001644	CARENA FRONTALE INFERIORE INOX PRONTOBAR	FRONT LOWER STAINLESS STEEL CASE - PRONTOBAR	
03001648	INSERTO INOX CENTRALE PORTA PRONTOBAR	STAINLESS STEEL CENTRAL DOOR INSERT - PRONTOBAR	
03001650	BASE TELAI0 PRONTOBAR	BASE FRAME - PRONTOBAR	
03001652	SUPPORTO TANICA PRONTOBAR	CONTAINER SUPPORT - PRONTOBAR	
03001653	LAMIERA PROTEZ.MOTORE GR.EROGAZIONE	MOTOR GROUP PRETECTION PANEL - PRONTOBAR	
03001654	LAMIERA CHIUSURA SUPPORTO TANICA PRONTOBAR	CONTAINER SUPPORT ENCLOSURE PANEL - PRONTOBAR	
03001656	LAMIERA PROTEZIONE SUPERIORE PRONTOBAR	UPPER PROTECTION PANEL - PRONTOBAR	
03001658	LAMIERA SUPPORTO MACININI PRONTOBAR	GRINDER SUPPORT PANEL - PRONTOBAR	
03001660	CARTER MACININO DX PRONTOBAR	RIGHT GRINDER CASE - PRONTOBAR	
03001662	CARTER MACININO SX PRONTOBAR	LEFT GRINDER CASE - PRONTOBAR	
03001664	SUPPORTO REGISTRO MACININO PRONTOBAR	GRINDER ADJUSTER SUPPORT - PRONTOBAR	
03001666	SUPPORTO LANCIA VAPORE + ACQUA CALDA PRONTOBAR	STEAM WAND + HOT WATER SUPPORT - PRONTOBAR	
03001668	LAMIERA SUPPORTO FRONTALE PRONTOBAR	FRONT SUPPORT PANEL - PRONTOBAR	
03001670	LAMIERA SUPPORTO CALDAIA PRONTOBAR	BOILER SUPPORT PANEL - PRONTOBAR	
03001672	LAMIERA SUPPORTO EV. PRONTOBAR	SOLENOID VALVE SUPPORT PANEL - PRONTOBAR	
03001674	LAMIERA SUPPORTO CENTRALINA PRONTOBAR	CENTRAL UNIT SUPPORT PANEL - PRONTOBAR	
03001676	LAMIERA CHIUSURA INTERNA PORTA PRONTOBAR	INTERNAL ENCLOSURE PANEL - DOOR - PRONTOBAR	
03001678	LAMIERA PROTEZIONE PULSANTIERA PRONTOBAR	KEYPAD PROTECTION PANEL - PRONTOBAR	
03001680	LAMIERA BECCO EROGAZIONE PRONTOBAR	DISPENSING SPOUT PANEL - PRONTOBAR	
03001682	LAMIERA SCARICO GR. PRONTOBAR	GROUP DRAINAGE PANEL - PRONTOBAR	
03001684	LAMIERA GRUPPO EROGAZIONE TEFLONATA PRONTOBAR	TEFLON DISPENSING GROUP PANEL - PRONTOBAR	
03001686	PIASTRA ADATTAMENTO MOTORE GR.EROGAZIONE PRONTOBAR	DISPENSING GROUP MOTOR ADAPTATION PLATE - PRONTOBAR	
03001688	PIASTRA SERRATURA PRONTOBAR	LOCK PLATE - PRONTOBAR	
03001690	RETINA A FILO INOX PIANO LAV. PRONTOBAR	STAINLESS STEEL MESH, WORK SURFACE - PRONTOBAR	
04000022.1	CAVO ELETTRICO 3x14AWG SJOOW UL 300V 90°C	3x14AWG SJOOW UL 300V 90°C ELECTRIC WIRE roll of 76m	
04000029	SPINA 20A 250V USA 5466X	PLUG 20A 250V 5466X	
04000198	PRESA LAMELLARE M 6.3 d4.2 45°	FOIL HOLDER M 6.3 D 4.2 45°	

P
R
O
N
T
O
B
A
R

CODICE	DESCRIZIONE	DESCRIPTION	DATA FINE VALIDITA'	P R O N T O B A R
04000199	PRESA LAMELLARE DOPPIA M 6.3 d4.2 45°	DOUBLE FOIL HOLDER M 6.3 D 4.2 45°		
04000310	MORSETTIERA A VITE FV110 230V 3 POLI	SCREW TERMINAL FV110 220 V		
04000312.A	SENSORE MAGNETICO L=400	MAGNETIC SENSOR L400		
04000313	UNITA' MAGNETICA M 305 AA	MAGNETIC UNIT M 305 AA		
04000562	CAVO ALIM. H05VV-F CE 3x1,5 SPINA SCHUKO 90°	POWER SUPPLY CABLE 3x1.5 CE 90° SCHUKO PLUG		
04000565	SENSORE MAGNETICO M8X30 L=300	WATER TANK MAGNETIC SENSOR M8x30 L=300		
04000572	CONNETTORE 4 VIE (4x1) M LOCK	4-WAY M LOCK CONNECTOR (4x1)		
04000578	CONNETTORE 6 VIE (3x2) M LOCK	6-WAY M LOCK CONNECTOR (3 x 2)		
04000604	SUPPLEMENTO EV ENTRATA MICROB.2004 ACQUASTOP	EXTRA INLET SOLENOID MICROB.		
04000670	CAVO CONTATORE VOLUMETRICO MUSICA	VOLUMETRIC COUNTER CABLE - MUSICA		
04000672	CAVO CONTATORE VOLUMETRICO ATT DIRETTO MUSICA	VOLUMETRIC COUNTER CABLE - MUSICA D.A.		
04000700	CABLAGGIO COMPLETO PRONTOBAR	COMPLETE WIRING ASSEMBLY - PRONTOBAR		
04000702	PROTEZIONE PVC CENTRALINA PRONTOBAR	CENTRAL UNIT PVC PROTECTION - PRONTOBAR		
04000704	CAVO INTERRUETTORE-MORSETTO PRONTOBAR	SWITCH/TERMINAL CABLE - PRONTOBAR		
04000706	CABLAGGIO BASSA TENSIONE PRONTOBAR	LOW VOLTAGE WIRING ASSEMBLY - PRONTOBAR		
04000708	CABLAGGIO SICUREZZA PRONTOBAR	EARTH WIRING ASSEMBLY - PRONTOBAR		
04000710	CAVO CONNES. CENTR.- DISPLAY PRONTOBAR NERO	CENTRAL UNIT/DISPLAY CONNECTING CABLE - BLACK PRONTOBAR		
04000712	CAVO CONNES. CENTR.- SCHEDA EROG. PRONTOBAR BIANCO	CENTRAL UNIT/DISPENSING CIRCUIT BOARD CONNECTING CABLE - WHITE		
04000714	CAVO TERMOSTATO CALDAIA PRONTOBAR CSA	BOILER THERMOSTAT/CABLE - PRONTOBAR CSA		
04000716	CAVO CONNESSIONE CENTRALINA - USB PRONTOBAR	CENTRAL UNIT/USB CONNECTING CABLE - PRONTOBAR		
04100042	E.V. NC 2VIE 1/8-1/8 220-230V 50/60Hz VITON F2 CE	ELECTR. 2-WAY 1/8" F2 230V 50/60Hz		
04100045	E.V. NO 2VIE 1/8M-PORTAGOMMA 230V 50/60Hz VITON F1.7 CE	2-WAY SOLENOID 1/8 M HOSE SUPPORT		
04100046	E.V. NC 3VIE 1/8-1/8 PORTAG. 230V 50/60Hz VITON F1.5 CE	ELECTR. 3-WAY 1/8" F1.5 230V 50/60Hz HOSE CLAMP OUTLET		
04100054	E.V. NC 3VIE 1/8-1/8 PORTAG. 220-230V 50/60Hz VITON F2 CE	ELECTR. 3-WAY 1/8" F2 230V 50/60Hz HOSE CLAMP OUTLET		
04100058	E.V. NC 2VIE 1/8-1/8 208-240V 60Hz VITON F2 UL	2-WAY SOLENOID 1/8-1/8		
04100060	E.V. NC 2VIE 3/4-JG 6 DIRITTA REGOL+FILTR F.2,5 230V 50/60Hz	2-WAY SOLENOID VALVE 3/4-JG 6 230V 50/60Hz		
04100062	E.V. NC 2VIE 3/4-JG6 DIRIT. UL REGOL+FILTR F.2,5 208/240V60Hz	2-WAY SOLENOID VALVE 3/4-JG 6 230V 60HZ UL		
04100066	E.V. NO 2VIE 1/8M-PORTAGOMMA 208/240V 60Hz VITON F1.7 UL	NO 2-WAY SOLENOID 1/8M-HOSE SUPPORT 230V 60Hz VITON F1.7 UL A		
04100067	E.V. NC 3VIE 1/8-1/8 PORTAG.UL 208/240V 60Hz VITON F1.5 V0	NC 3-WAY SOLENOID 1/8-1/8 HOSE SUPPORT 208-240V 60Hz VITON F1		
04100068	E.V. NC 3VIE 1/8-1/8 PORTAG. 208-240V 60Hz VITON F2 UL	3-WAY SOLENOID 1/8-1/8 HOSE SUPPORT 208-240V 60Hz F.2		
04100070	E.V. NC 2VIE 1/8-1/8 208-240V 60Hz VITON F1.5 UL	2-WAY SOLENOID 1/8-1/8 208-240V 60Hz F.1,5		
04200011	INTERRUTTORE BIPOLARE LUMINOSO ROSSO	BIPOLAR LUMINOUS SWITCH		
04200043	MICRO PORTA/CASSETTO MASTER/ MICROBAR/CAFF. ITA.	DOOR DREGS DRAWER MICRO-SWITCH		
04200063	MICROSWITCH PORTA	DOOR MICROSWITCH		
04600014	MOTORIDUTTORE SX 24V cc. D.43400 RPM + ENCODER "HALL"	LEFT 24V AC GEAR MOTOR REDUCER D.43400 RPM + "HALL" ENCODER		
04800005	POMPA ELETTROMECC. 230V 50Hz	VIBRATION PUMP V230/50		
04800007	POMPA ELETTROMECCANICA 220V 60Hz 64W	ELECTROMECHANICAL PUMP 220V 60Hz 64W		
04900027	DOSATORE VOLUMETRICO OTT.	FLOWMETER		
04900056	SONDA TEMP. PTP-51F R100 3,3K F.4 L=280 MOD2	PTP-51F R100 3.3K TEMP PROBE		
04900652	TRASF.COMPL.MICROBAR 230V/18V 150VA 50/60Hz FUSE750mA	MICROBAR COMPLETE TRANSFORMER 230V-18 150VA 50/60Hz FUSE750m		
04900660	DOSATORE VOLUMETRICO NSF PLASTICA BASSA PRESSIONE	FLOWMETER NSF LOW PRESSURE		
04900775	SONDA TEMPERATURA 150° NTC ATT.1/8 INOX 4x20	TEMPERATURE PROBE 150° NTC ATT.1/8 SS 4x20 Lwire=500 mm. A		
04900780	SONDA PT1000 x LANCIA VAPORE + SUPPORTO	PROBE PT1000 X STEAM WAND "TURBO CREAM" D06		
04900902	SCHEDA EROGAZIONE PRONTOBAR	DISPENSING CIRCUIT BOARD - PRONTOBAR		
04900908	DISPLAY GRAFICO 4 RIGHE PRONTOBAR	4-LINE GRAPHIC DISPLAY - PRONTOBAR		
04900910	CENTR. ELETT. PRONTOBAR 18Vac	CENTRAL UNIT - PRONTOBAR 230V		
04900912	SCHEDA USB CENTRALINA PRONTOBAR	CENTRAL UNIT - PRONTOBAR 110V		
05000001	GOMMINO PROTEZIONE LANCIA D.10	STEAM ARM RUBBER GRIP		
05000012	RACCORDO PORTATUBO 6	TS 6 HOSE FASTENING		
05000015	RACCORDO PORTATUBO WES 6R 1/8	WES 6R 1/8 HOSE FASTENING		
05000029	POMELLO M4x20 TESTA D.13x4	KNOB M4x20		
05000083	BLOCCACAVO SR 11-2 NERO	CABLE BLOCK SR 11-2		
05000086	PASSACAVO A MEMBRANA BIANCO	MEMBRANE CABLE DUCT		
05000110	RACCORDO DECAFFEINATO MASTER *	DECAF CONVOY		
05000242	TAPPO COPRIFORO D.31 NERO SP-1093	COVER PLUG D.31 BLACK		
05000530	PIEDINO MACININO/JAZZ D.3/6 STEAB 6304 PVC NERO	FOOT JAZZ/GRINDER STEAB 6304 BLACK		
05000737	BOCCOLA MOV. ESPULSIONE MICROBAR	MICROBAR UNIT EJECTION BUSHING		
05000743	PISTONE INF. D.43 NYLON GR. MICROBAR	MICROBAR GROUP LOWER PISTON D.43		
05000744.1	CHIOCCIOLA VITE MOVIMENTO T.N.NYLON MICROBAR	MICROBAR VOLUTE MOVEMENT SCREW		
05000746	CLIP FERMATUBO D.8	PIPE-HOLDER CLIP D.8		
05000753	GOMMINO CORNICE CARENA MICROBAR D.6	MICROBAR BASE FRAME GROMMET		
05000758.CH	COPERCHIO VASCHETTA ACQUA 5LT PRONTOBAR CHAMPAGNE	COLOR AG 722A + TRASPARENTE OPACO		
05000758.N	COPERCHIO VASCHETTA ACQUA 5LT PRONTOBAR NERO OPACO	OPACO 100% + TRASPARENTE OPACO		
05000759	COLLETTORE CONTENITORE ACQUA 5LT MICROBAR	MICROBAR WATER CONTAINER MAINFOLD 5LT		
05000762	RACCORDO PORTATUBO GES 6 1/8 MASCHIO DIRITTO	STRAIGHT FITTING - PIPE HOLDER 1/8		
05002020	ATTACCO SCARICO VASCHETTA TALENTO	TRAY WASTE FASTENING TALENTO		
05002102	VASCHETTA RACCOGLIACQUA PRONTOBAR NERO	WATER COLLECTION TRAY - PRONTOBAR		
05002106.CH	COPERCHIO CARENA PRONTOBAR CHAMPAGNE	CASE COVER CHAMPAGNE - PRONTOBAR		
05002106.N	COPERCHIO CARENA PRONTOBAR NERO OPACO	CASE COVER BLACK OPAQUE - PRONTOBAR		
05002108.CH	COPERCHIO 2° MACININO PRONTOBAR CHAMPAGNE	AG 722A + TRASPARENTE OPACO		
05002108.N	COPERCHIO 2° MACININO PRONTOBAR NERO OPACO	100% + TRASPARENTE OPACO		
05002110	CONVOGLIATORE DECA PRONTOBAR	DECAFFEINATED CONVEYOR - PRONTOBAR		
05002113	PELLICOLA ADESIVA PER CAMPANA PRONTOBAR	ADESIVE FILM COFFEE BELL - PRONTOBAR		
05002114	COPERCHIO CAMPANA CAFFE' PRONTOBAR	COFFEE FUNNEL COVER - PRONTOBAR		
05002116.CH	PORTA FRONTALE PRONTOBAR CHAMPAGNE	FRONT DOOR CHAMPAGNE - PRONTOBAR		
05002116.N	PORTA FRONTALE PRONTOBAR NERO OPACO	FRONT DOOR BLACK OPAQUE - PRONTOBAR		
05002118	ETICH. LEGENDABILI PULS. PRONTOBAR NERO 11 BEVANDE	KEY LEGEND DECALS - PRONTOBAR BLACK		
05002118.1	ETICH. LEGENDABILI PULS. PRONTOBAR GRIGIO 11 BEV.	KEY LEGEND DECALS - SPECIAL COLOUR PRONTOBAR		
05002120.G	INSERTO DX PORTA FRONTALE PRONTOBAR SERIGR. GRIGIO	FRONT DOOR RIGHT INSERT GREY - PRONTOBAR		
05002120.N	INSERTO DX PORTA FRONTALE PRONTOBAR SERIGR. NERO	FRONT DOOR RIGHT INSERT BLACK - PRONTOBAR		
05002122.G	INSERTO SX PORTA FRONTALE PRONTOBAR SERIGR. GRIGIO	FRONT DOOR LEFT INSERT GREY - PRONTOBAR		
05002122.N	INSERTO SX PORTA FRONTALE PRONTOBAR SERIGR. NERO	FRONT DOOR LEFT INSERT BLACK - PRONTOBAR		
05002124	PROTEZIONE DISPLAY PRONTOBAR	DISPLAY PROTECTION - PRONTOBAR		
05002126	SUPPORTO EROGATORE PRONTOBAR GRIGIO	DISPENSER SUPPORT - PRONTOBAR		
05002128	BECCO EROGATORE PRONTOBAR GRIGIO	DISPENSER SPOUT - PRONTOBAR		
05002130	SUPPORTO TUBI EROGAZIONE PRONTOBAR GRIGIO	DISPENSER TUBING SUPPORT - PRONTOBAR		
05002132	REGISTRO INCLINAZIONE SCIVOLO CAFFE' PRONTOBAR	COFFEE CHUTE ANGLE ADJUSTER - PRONTOBAR		
05002134	SUPPORTO SCIVOLO CAFFE' PRONTOBAR	COFFEE CHUTE SUPPORT - PRONTOBAR		
05002136	SCIVOLO CAFFE' SX PRONTOBAR	LEFT COFFEE CHUTE - PRONTOBAR		
05002138	SCIVOLO CAFFE' DX PRONTOBAR	RIGHT COFFEE CHUTE - PRONTOBAR		
05002140	CHIUSURA SCIVOLO CAFFE' SX PRONTOBAR	LEFT COFFEE CHUTE ENCLOSURE - PRONTOBAR		
05002142	CHIUSURA SCIVOLO CAFFE' DX PRONTOBAR	RIGHT COFFEE CHUTE ENCLOSURE - PRONTOBAR		
05002144	PALETTA ESPULSIONE PRONTOBAR	EJECTION BLADE - PRONTOBAR		
05002227	DISTANZIALE ESAGONO 6 M3 h8	SHIN M3 H8		
05002228	COLLETTORE SCARICO GRUPPI EROG	POURING UNIT DRAIN MANIFOLD		

CODICE	DESCRIZIONE	DESCRIPTION	DATA FINE VALIDITA'
05002230	TAPPO GOMMA SCARICO x 05002228	DRAIN RUBBER PLUG	
05002236	DISTANZIALE ESAGONO 6 M3 h20	SHIN M3 H20	
05180005	SUPPORTO POMPA AD L	L-SHAPED PUMP BRACKET	
05340020	PROTEZIONE x PRESA USB	USB PLUG PROTECTION	
07300001	RACCORDO L 1/8 M-M 459	L FITTING 1/8 M-M	
07300005	PORTAGOMMA ANG. 1/8 X 7 F1 4.8AGG. 18.06.96	ANGULAR HOSE CLAMP 1/8"	
07300101	DADO RACCORDO 1/8 GAS <	1/8 GAS CONNECTION NUT	
07300128	TAPPO 1/4 GAS AGG.31.01.89	CAP 1/4 GAS	
07300129	TAPPO 1/8 GAS	CAP 1/8 GAS	
07300201	RACCORDO CIL. 6/4 M6 340/M	TEFLON TUBE M6 FITTING	
07300203	PORTAGOMMA CIL. 7 1/8 454/A	CILINDRICAL HOSE CLAMP 1/8	
07300218	RACCORDO L 1/8 M-F 458	L FITTING 1/8 M-F	
07300233	TERMINALE CHIUSO D.8	CLOSED TERMINAL D 8	
07300248	RACCORDO 3/8M-PORTAGOM. LANCIA	UNION 3/8M - HOSE CLAMP FOR WAND	
07300251	RACCORDO 1/8 M-M FORO 5,5 + FILETT. M6 x L.=11	UNION 1/8 M-M HOLE 5.5 + M6 x L = 11	
07300255	PERNO SERRATURA PRONTOBAR	LOCK PIN - PRONTOBAR	
07300257	VITE MOVIMENTO GR. PRONTOBAR INOX	STAINLESS STEEL SCREW FOR GROUP MOVEMENT - PRONTOBAR	
07300259	ALBERO PALETTA ESPULSIONE GR. PRONTOBAR	GROUP EJECTION BLADE SHAFT - PRONTOBAR	
07300293	BUSSOLA SNODO OTT. AG.25.06.96	BRASS BUSHING	
07300295	DADO RACC. 3/8 LANCIA SNODATA OTTONE NICHELATO	WAND NUT 3/8	
07300361	RACCORDO L GIR 1/4 M-CALZAM.6 VITON 346 A	PIVOTING CONNECTION L 6 1/4 VITON346A	
07300369	RACCORDO ATTACCO DIRETTO PER POMPA	FITTING DIRECT DISCHARGE FOR ELECTROMECHANICAL PUMP	
07300376	RACCORDO DIR.F. 6 1/8-CALZAM.	STRAIGHT FITTING F6 1/8	
07300452	RACCORDO T 1/8 M-M-F 465	T CONNECTION 1/8 M-F-F 465	
07300453	RACCORDO T 1/8 M-M-M	SPACER D4.5DE14 SP.6 BRASS	
07300503	ALBERO PISTONE INF.SCARICO MICROBAR	MICROBAR GROUP DRAIN LOWER PISTON SHAFT	
07300505	BOCCOLA ALBERO PISTONE SCARICO	MICROBAR DRAIN PISTON SHAFT BUSHING	
07300512	PIATTELLO PORTAMOLLA INFERIORE GR. MICROBAR	MICROBAR GROUP LOWER SPRING WASHER	
07300513	PIATTELLO PORTAMOLLA SUPERIORE GR. MICROBAR	MICROBAR GROUP UPPER SPRING WASHER	
07300522	VITE REGOLAZIONE MACINATURA MICROBAR	MICROBAR GRINDING ADJUSTMENT SCREW	
07300526	RACCORDO PORTAGOMMA 1/8M 120° 488/B 6	HOSE LAMP FITTING 1/8 M 120°	
07300529	MANICOTTO FILETTATO 1/8 450	THREADED SLEEVE 1/8	
07300539	RACCORDO RAPIDO 1/8 DIRITTO D4	QUICK COUPLING 1/8 STRAIGHT D4	
07300542	RACCORDO RAPIDO M6 L GIR. D4	L FITTING QUICK COUPLING M6 L SWIVEL D4	
07300544	PROLUNGA MF 1/8" ES 14 x FILTRO INOX D8	EXTENSION M-F 1/8	
07300545	SPESSORE PER SCROCCETTO PORTA MICROBAR	MICROBAR DOOR LOCK SHIM	
07300562	BOCCOLA FLANG. PER VITE GR. ERMICROBAR 08	MOTION SCREW BRASS BUSHING - MICROBAR 08	
07300566	COLONNA INOX 430 GRUPPO MICROBAR 08	STAINLESS STEEL GUIDE ROD 430 MICROBAR08 GROUP	
07300616	PERNO CARENA M4 MICROBAR	MICROBAR CASE PIN M4	
07300625	SPESSORE OT D.20 H=13.5 F.12.5STOP INF.GR.MICROBAR	SPACER D20 H13.5 GR MICROBAR	
07300653	RONDELLA OT D.20x8.1xS.2	BRASS WASHER D.20x8.1xTh.2	
07300662	PISTONE EROG. SUP. TALENTO RESINA ACETALICA	TALENTO TOP POURING PISTON ACETALIC RESIN	
07300714	RACCORDO L 1/8 M - CALZAM.6	L FITTING 1/8 SHEAT TYPE D6	
07300715	RACCORDO T 1/8 M -CALZAM.6 - CALZAM.6	1/8 M T CONNECTION - D. 6 PIPE	
08000003	FASCETTA STRINGITUBO D9.1	HOSE CLAMP D9.1	
08000015	ANELLO SEEGER TIPO RS 5 INOX UNI 7434	SEEGER RING RS 5 STAINLESS STEEL	
08000027	MOLLA PER LANCIA SNODATA	WAND SPRING	
08000038	MOLLA A TAZZA 15x6,2x0,5x0,5	BELLEVILLE WASHER 15x6.2x0.5x0.5	
08000047	SEEGER ESTERNI INOX A 10	EXTERNAL SEEGER RING STAINLESS STEEL A 10	
08000071	CUSCINETTO ASSIALE COMPONIBILE 10x19x6	MODULAR AXIAL BEARING 19x10x6	
08000078	MOLLA LUNGA PISTONE SCARICO GRUPPO MICROBAR	MICROBAR GROUP DISCHARGE PISTON LONG SPRING	
08000079	MOLLA CORTA PISTONE SCARICO GRUPPO MICROBAR	MICROBAR GROUP DISCHARGE PISTON SHORT SPRING	
08000081	MOLLA RICHIAMO SCIVOLO MOBILE MACININO SX MICROBAR	MICROBAR LEFT GRINDER MOBILE CHUTE RECALL SPRING	
08000083	COPIGLIA ELASTICA D.2 L.43 C70 ZINCATO	RETAINER CLIP D.2 L.43 c70 GALVANISED	
08000084	COPIGLIA D.2 L.20 INOX 304 UNI 1336 - DIN 49 - ISO 1234	RETAINER CLIP D.2 L.20 304 SS UNI 1336 - DIN 49 - ISO 1234	
08000085	MOLLA PALETTA ESPULSIONE GR.TALENTO	TALENT GROUP SCOOP SPRING	
09000007	SONDA AUTOLIVELLO COMP. L=85 CON GOLA	SELF-LEVELLING DEVICE COMPLETE	
09500001	TERMOSTATO RIARMO AUTOM 98°C	98°C AUTO RESET THERMOSTAT	
09500007	TERMOPROTEETTORE 2MMT 100°C	2MMT 100°C THERMAL PROTECTION	
09500011	TERMOSTATO R.AUTO 150°C FASTON 6,3 VERTICALI	TERMOSTATO R.AUTO 150°C FASTON 6,3 VERTICALI REPLACE CODE 4090	
09500015	TERMOPROTEETTORE RESISTENZA G5 184°C 16A 250V UL	HEATING ELEMENT THERMAL PROTECTION G5 184°C 16A 250V UL	
14100055	RESISTENZA A CARTUCCIA HW10x65 100W 230V	CARTRIDGE HEATING ELEMENT HW10x65 100W 230V	
15000040	CHIUSURA CAMPANA MDX/L51010020	GRINDER REGISTER SLIDE	
15050011	CHIUSURA SICUR.CAMPANA 5101.0012	BELL SAFETY COVER 5101.0012	
15050023	CONDENS. 16mF 450V 40x70 UL FASTON M6,3	CAPACITOR	
15800038	DADO BLOCCAGGIO MACINE MCF	MCF GRINDER LOCK NUT	
15800045	COPPIA MACINE D50 3 FORI POWER	POWERGRINDER BLADE PAIR D50 3 HOLES	
11600001.B	TUBO SILICONE BLU 4x7,5 60Sh (1mt=41gr)	4x7.5 60Sh BLUE SILICONE TUBE (1m=41g) SEMITRANSP PLATIN.	
11600001.R	TUBO SILICONE ROSSO 4x7,5 60Sh(1mt=41gr)	RED SILICON PIPE 4x7.5 60Sh SEMI-TRANSPARENT	
11600001.W	TUBO SILICONE BIANCO4x7,5 60Sh(1mt=41gr)	WHITE SILICON PIPE 4x7.5 60 ShSEMI-TRANSPARENT	
11600002	TUBO SILICONE 5x8 60Sh PEROX (1mt=37gr)	SILICONE TUBE 5x8	
11740001	TUBO TEFLON 6/4	TEFLON PIPE 4X6	
11740002	TUBO TEFLON 4/2,5 CALIBRATO TRASPARENTE	TEFLON PIPE 4/2.5 CALIBRATED TRANSPARENT	
40000003	VITE INOX M5x10 TSP TC UNI6109 X DOCCIA	SS SHOWER SCREW M5x10 TSP TC	
40000013	VITE INOX M8x25 TBEI	SS SOCKET CAP SCREW M8x25	
78006005	LANCIA VAPORE SNODATA CROMATA PREMIER 2001 D10	STEAM ARM	
78007005	LANCIA ACQUA CALDA SNODATA CROMATA PREMIER 2001	JOINTED HOT WATER WAND CHROME PREMIER 2001	
84003002	BECCO ACQUA CALDA E VAPORE LANCIA MICROBAR 4 FORI	HOT WATER AND STEAM NOZZLE SPOUT 4 HOLES	
84003003	TUBO RAME D6 CALDAIA MICROBAR	MICROBAR BOILER COPPER PIPE D6	
84005001	PORTAMACINE SUPERIORE DENTATO MICROBAR	MICROBAR SERRATED UPPER BLADE SUPPORT	
84005004	MOTORE MACININO MICROBAR 120W 230V/50Hz	MICROBAR GRINDER MOTOR 230V 50Hz REPLACE CODE 85040002	
85060006	PORTAMACINE INF. LAVORATO	PORTAMACINE INF. LAVORATO LOWER DECOR. BLADE SUPPORT	
98001005	PIEDE MACCHINA BICOMPONENTE D.48 H=40	BICOMPONENT MACHINE FOOT D.48 H = 40 INSERT M8 FEMALE	
98004016	FILTRO INOX DIAM. 12	STAINLESS FILTER DIAM. 12	
980100000011200001	ASSIEME CASSETTO FONDI PRONTOBAR	DREGS DROWER ASSEMBLY - PRONTOBAR	
9801000000011200002	ASSIEME CASSETTO FONDI PRONTOBAR SCARICO DIRETTO	DREGS DROWER ASSEMBLY (DIRECT DRAIN) - PRONTOBAR	
98010000000118	ASSIEME CAMPANA PRONTOBAR	COFFEE BELL ASSEMBLY - PRONTOBAR	
98030308	CALDAIA SALD. ACCIAIO Aisi316 MICROBAR 08 230V 1000W	BOILER MICROBAR 08 230V	
98030380	TUBO INF. CALDAIA ACQUA CALDA PRONTOBAR	LOWER HOT WATER BOILER TUBE - PRONTOBAR	
98030382	TUBO INF. CALDAIA VAPORE PRONTOBAR	LOWER STEAM BOILER TUBE - PRONTOBAR	
98030384	TUBO SUP. CALDAIA ACQUA CALDA PRONTOBAR	UPPER HOT WATER BOILER TUBE - PRONTOBAR	
98030386	TUBO SUP. CALDAIA VAPORE PRONTOBAR	UPPER STEAM BOILER TUBE - PRONTOBAR	
980300000009600001	ASSIEME CALDAIA CAFFE' PRONTOBAR CE	COFFEE BOILER ASSEMBLY - PRONTOBAR CE	
980300000009600002	ASSIEME CALDAIA CAFFE' PRONTOBAR CSA	COFFEE BOILER ASSEMBLY - PRONTOBAR CSA	
980300000009800001	ASSIEME CALDAIA VAPORE PRONTOBAR CE	STEAM BOILER ASSEMBLY - PRONTOBAR CE	

P
R
O
N
T
O
B
A
R

CODICE	DESCRIZIONE	DESCRIPTION	DATA FINE VALIDITA'
980300000009800002	ASSIEME CALDAIA VAPORE PRONTOBAR CSA	STEAM BOILER ASSEMBLY - PRONTOBAR CSA	
980400000000060	ASSIEME GRUPPO EROGAZIONE PRONTOBAR	POURING GROUP ASSEMBLY - PRONTOBAR	
980400000000062	GRUPPO D43 PRONTOBAR LAVORATO CON CAMICIA INOX	MACHINED GROUP - PRONTOBAR	
980400000000064	SUPPORTO GRUPPO LAVORATO PRONTOBAR	MACHINED UNIT - PRONTOBAR	
980600000000006	LANCIA AUTOSTEAM "ADONIS"	AUTOSTEAM WAND "ADONIS"	
98110001	VALVOLA RITEGNO COMPL. 1/8 F-F	RETAIN VALVE 1/8 F-F	
98120001	VALVOLA NEPLAX VITON 16BAR 1/8 - PORTAGOMMA	NEPLAX VITON 16BAR VALVE 1/8 HOSE CLAMP	
98120002	VALVOLA NEPLAX VITON 6 BAR 1/8 - PORTAGOMMA	NEPLAX VITON 6 BAR VALVE 1/8 - HOSE SUPPORT	
98120003	VALVOLA NEPLAX VITON 10BAR 1/8 - PORTAGOMMA	NEPLAX VITON 10BAR VALVE 1/8 HOSE CLAMP	
981400000000030	ASS.MACININO DX PRONTOBAR	RIGHT GRINDER ASSEMBLY - PRONTOBAR	
981400000000032	ASS.MACININO SX PRONTOBAR	LEFT GRINDER ASSEMBLY - PRONTOBAR	
982000000000022	ASS. TANICA ACQUA 5LT CON GALLEGGIANTE	WATER CONTAINER COMPLETE 5 LITRES	
982100000000320001	ASSIEME E.V. ALLUNGO PRONTOBAR CE	EXTRAWER ASSEMBLI - PRONTOBAR CE	
982100000000320002	ASSIEME E.V. ALLUNGO PRONTOBAR CSA	EXTRAWER ASSEMBLI - PRONTOBAR CE	

P
R
O
N
T
O
B
A
R